

Total Control : Peace of mind



SMS Commander Manual

For the GB0101S

V1.2



Before Attempting to connect or operate this product, please read these instructions in its entirety, **especially the guarantee conditions.**

TABLE OF CONTENTS

Introduction.....	3
Features.....	3
Specifications.....	3
Dimensions.....	4
Installation.....	4
Power Supply.....	4
Environment.....	5
SIM Card.....	5
Antenna.....	6
Mounting.....	6
Optically-Isolated Digital Input.....	6
Output.....	8
Battery Input.....	9
Status LEDs.....	9
Testing the SMS Commander.....	10
Configuration.....	11
Administrative Commands.....	11
Number Management.....	11
TRIGGER-ACTION Behaviour Statements.....	12
Trigger Conditions.....	12
Action Conditions.....	13
Examples.....	13
Troubleshooting.....	14
Guarantee.....	14
Important Notice (Disclaimer / Copyright).....	15
Manufacturer Contact details.....	15

1. INTRODUCTION

The Polygon Technologies SMS Commander is a state-of-the-art, programmable SMS controller. It contains a quad-band integrated GSM cellular engine that allows it to connect to any cellular network to send and receive SMS messages. The product can be used to monitor an input, and remotely control electric devices. The product is configured via simple SMS messages.

2. FEATURES

Model	Onboard Inputs	Onboard Outputs	Expandable Inputs/Outputs	Max Number of Statements	Max number of Phone Numbers	Max number of Sent Messages	Max Length of Messages	Battery / Power Monitor	Configuration Via USB
GB0101S	1	1	NONE	8	16	8	16	YES	NO

Matrix Feature Descriptions

Onboard Inputs	The number of inputs provided on the base unit itself
Onboard Outputs	The number of outputs provided on the base unit itself
Expandable Inputs/Outputs	The maximum total number of Inputs/Outputs that can be expanded to by fitting expansion units
Max Number of Statements	A measure of the amount of complexity that can be programmed into the unit. Each statement is of the form BEHAVE <x> <ABC happens> <do something> such as IF Input 1 goes Active, THEN send "Generator Tripped" to "0831231234"
Max Number of Phone Numbers	The maximum total number of phone numbers that can be programmed into the unit
Max Number of Sent Messages	The maximum total number of messages that can be programmed into the unit to be sent via SMS.
Battery / Power Monitor	The ability to detect power failures and monitor a connected battery.
Configuration Via USB	A unit with this feature can be configured via software from a PC.

3. SPECIFICATIONS

Weight	100gram
Dimensions	125,7mm x 71,9mm x 26mm
Power Supply	10...16V DC (Absolute MAX=18V)
Current Consumption	~50mA (Idle: Input & Output off) ~110mA (Output on) ~100mA (Input on Dry contact) ~60mA (Input on Wet contact)
Operating Temperature	-10°C to +60°C

4. DIMENSIONS

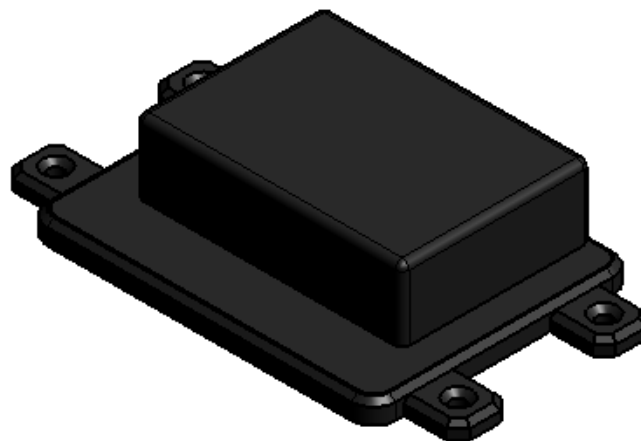
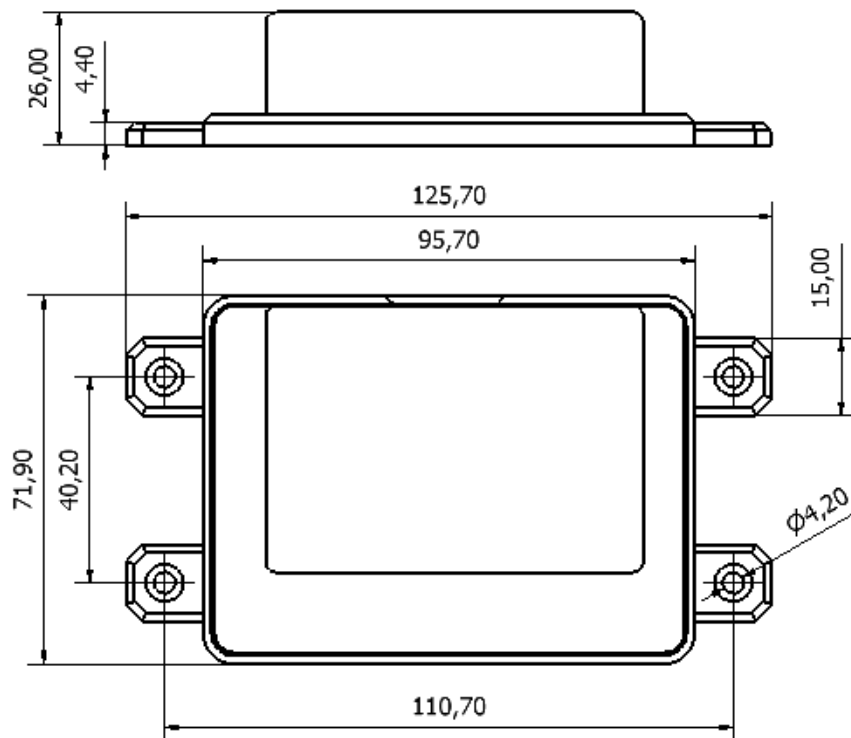

5. INSTALLATION

5.1. Power Supply

The SMS Commander has a 2.1mm DC jack connector where a power supply must be connected. The power supply should have the following specifications:

- Output Voltage: 12V nominal
- Output Current: 0.5A
- Polarity: 

A suitable power supply is supplied with the retail product.

In industrial applications, it is advised that the SMS Commander be installed into its own metal housing and be powered from a separate power supply. (As opposed to sharing one with other equipment).

PLEASE NOTE: While the product has fairly rugged internal power supply circuitry, no special provision for lightning protection is made. If the product is used in an area that is prone to thunderstorms, it is advisable to use a commercially available lightning suppressor (The same applies to the input or output if connected to wires longer than 2 or 3 meters).

The guarantee does not cover damage resulting from lightning strikes or voltage surges! The SMS Commander can operate reliably from voltages in the range of 10 to 16V DC.

5.2. Environment

Due to the make-up of the SMS Commander and its electronics, we **STRONGLY** advise that it not be installed in close proximity to a variable speed drive or any other electrically noisy equipment. **DO NOT** install the SMS Commander into a metal enclosure unless an antenna is mounted on the outside of the enclosure.

5.3. SIM Card

The SMS Commander accepts a standard GSM SIM card from any network. The SIM card may be prepaid or on contract. If the SIM Card is purchased as part of a prepaid plan, ensure that the card is loaded with sufficient airtime.

WARNING: DO NOT Insert or remove the SIM card while the SMS Commander is powered!!

Note that airtime will decrease with every SMS that is sent from the unit. The unit can automatically detect if the airtime is running low. It is user's responsibility to make sure that the airtime is topped up. See your network's documentation on how to purchase and load airtime.

The SIM card is fitted into the back of the unit, as indicated by the legend on the enclosure. The SIM card will click into place. The SIM card is removed simply by pressing against it. The card will pop out with a "click" sound, ready to be completely removed.

Before you install your SIM Card:

- Install the SIM card into a normal cellular phone
- Verify that there is **no SIM PIN** enabled (The phone must not ask for a PIN when switched on with this SIM card inside) If the phone does request a PIN, you need to enter the correct pin so that the phone can start, and then disable the SIM Card PIN. See your cellphone documentation on how this can be done.
- Verify that you are able to **send an SMS** message.

The SIM card will now work with the SMS Commander.

Please Note: If you are using a prepaid SIM card, be aware that if the SIM card has not produced a billable event on the network for a long period of time (typically 3 months), the card will be deactivated by the network, and the SIM card then becomes useless. It is strongly recommended that you send the SMS Commander a "TEST" SMS every now and then (once a month) so that your SIM card remains active on the network.

The SMS Commander can **ONLY** check the airtime of a **PREPAID** SIM card.

5.4. Antenna

The SMS Commander is supplied with a basic antenna operating in the **GSM 900MHz** and **1800MHz** frequency bands. Screw the antenna to its connector on the unit (only finger-tight). Verify using a cellphone, that there is sufficient signal at the proposed installation site.

On a phone with a 4 or 5-bar signal strength indicator, you should have at least 1-2 bars of signal. If the signal is too weak, the SMS Commander may have trouble sending or receiving SMS messages. In these cases, try and find a better location, or order one of our special antennas.

If you are outside South Africa, you may require a different antenna.

The other frequency bands are:

- **GSM 850MHz**
- **PCS-1900MHz**

Your network will be able to tell you which frequency band(s) are in use. Contact your local electronics supplier about antennas that operate in the 850MHz or 1900MHz bands.

Contact **Polygon Technologies** with your request for a special antenna.

5.5. Mounting

The SMS Commander is housed in a very durable ABS casing which has 4 protruding tabs, which allows it to be mounted firmly to any surface by means of 4 screws.

Please note: The SMS Commander is not water- or weatherproof. The SMS Commander must be mounted indoors, or inside an appropriate IP65-rated weatherproof enclosure. The guarantee does not cover damage resulting from water ingress!

Do not mount the SMS Commander inside a steel cabinet, since this will block the cellphone signal. If you have to mount it inside a steel cabinet, you will need to mount a separate antenna on the outside of the cabinet.

Suitable antennas can be ordered from **Polygon Technologies**.

5.6. Optically-Isolated Digital Input

The SMS Commander provides 1 signal input. The input has 4 terminals associated with it:

- +** – Internal positive supply (12V)
- IN +** – Positive input
- IN -** – Negative input
- – Internal negative supply (Zero volts)

To connect a switch or contact to an input, simply connect the switch between the + and IN+ terminals, and a wire between the – and IN – terminals, as shown below.

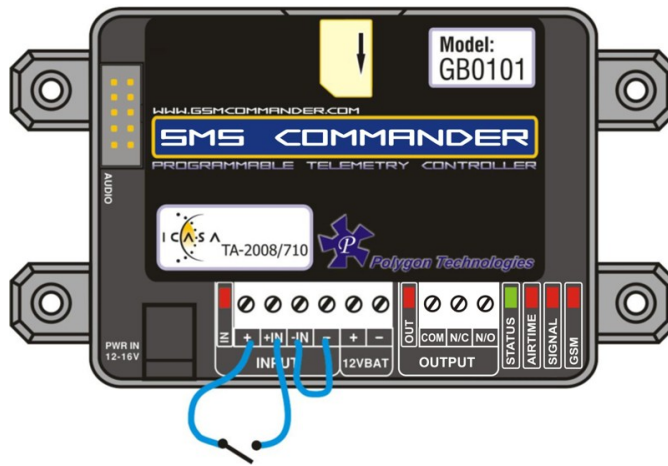

You may need an input to activate when power is supplied from some other unit. A good example will be a burglar alarm that applies power to the wires going to the siren. In such a case, it will be a simple matter of connecting the positive wire to the IN+ input, and the negative wire to the IN- input.

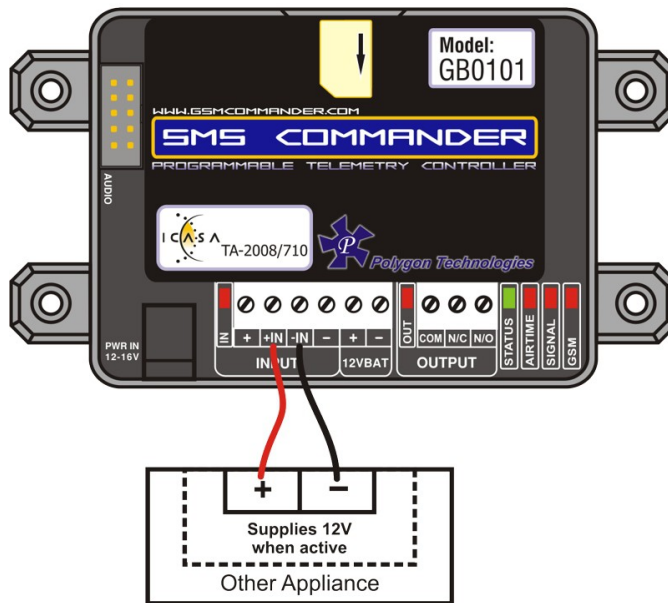

Please keep in mind that these inputs are designed for 5V to 18V operation. If you require to connect a voltage above 18V to these terminals, you should connect a resistor in series with the input, as shown below.

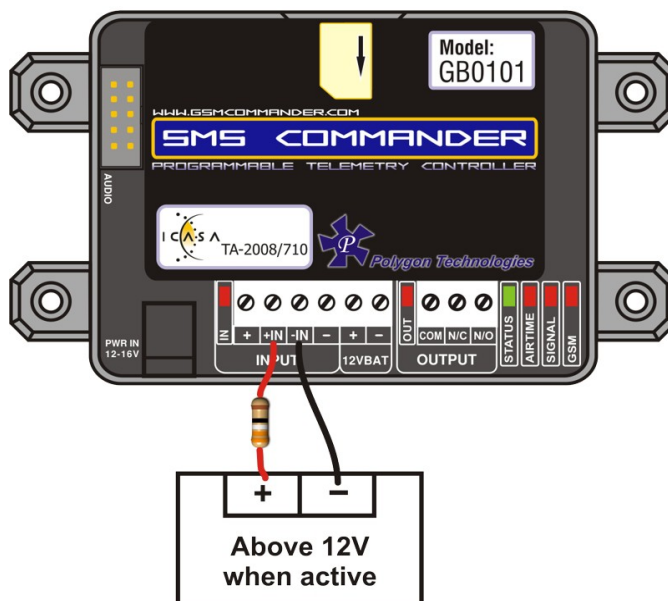

Input Voltage range

18V - 25V

25V - 32V

Required Series resistor:

560 ohm

2200 ohm

5.7. Output

8A Relay output

The SMS Commander has a single Relay output. The output has 3 terminals associated with them:

COM – Common Terminal

N/C – Normally Closed Terminal

N/O – Normally Open Terminal

When the output is off, the **COM** and **N/C** terminals will be internally connected to each other. When the output is on, the **COM** and **N/O** terminals will be internally connected to each other.

Note that there are small LED indicators next to the output terminals, that will show if the output is ON or OFF (if the LED is on, then the output is also on). In the picture below, the output is connected so that the lamp will light up when the output is on.

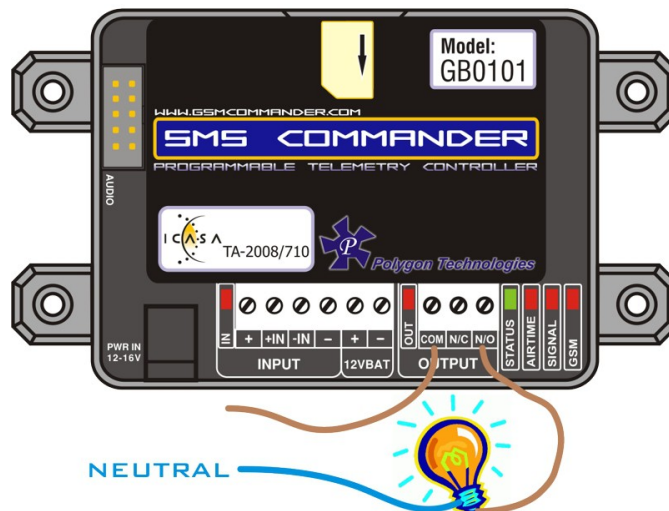

The output can be used to control devices and appliances, and is rated for 8A DC. It may be used to control most types of electrical loads, excluding AC motors above 500W.

Here are some examples of things you CAN directly switch on and off using the outputs on the product:

- Gate motors and any other motor less than 500W
- Mains Lights (energy savers, incandescents, halogens) (maximum 750W)

Here are some examples of things that you can NOT directly switch on and off using the outputs on the product:

- Ovens, Heaters, kettles
- Baby GSM
- Pumps and motors above 500W

Keep in mind that if required, the above loads can easily be switched on and off using an externally connected relay or contactor.

5.8. Battery Input

The SMS Commander provides connections for an external rechargeable 12V battery. The battery is continuously trickle-charged from the SMS Commander, as long as there is power supplied to the power connector of the SMS Commander.



In the case of a power failure, the SMS Commander can continue operating from the external battery. The unit can be configured to perform certain tasks (like sending a warning SMS) if the battery voltage falls below a certain point, and can also perform tasks in the case of a power failure. (Like sending an SMS and switching on emergency lighting)

Suitable batteries are available from **Polygon Technologies**.







5.9. Status LEDs

The SMS Commander has 4 LEDs to show the current status of the product. The green LED, labeled "STATUS", shows the current status of the product as a whole, while the other 3 red LEDs labeled "AIRTIME", "SIGNAL" and "GSM" show the airtime, signal and GSM status respectively.





GREEN LED (STATUS)

- on for 1500ms and off for 1500ms (very slow flash)
 : Busy Booting
- on for 500ms, off for 500ms (slow flash)
 : All OK
- on for 50ms, off for 450ms (intermittent flash)
 : Busy sending SMS/Voice Call
- on for 100ms, off for 100ms (very fast flash)
 : Problem with boot sequence



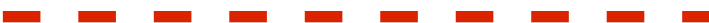

RED LED (AIRTIME)

- on for 1500ms and off for 1500ms (very slow flash)
 : Busy Booting
- on for 500ms, off for 500ms (slow flash)
 : Airtime > 20 units
- on for 250ms, off for 250ms (fast flash)
 : 10 units <= Airtime <= 20 units
- on for 100ms, off for 100ms (very fast flash)
 : Airtime < 10 units
- constantly on
 : Airtime = 0 units
- constantly off
 : Airtime unknown

RED LED (SIGNAL)

- on for 1500ms and off for 1500ms (very slow flash)
 : Busy Booting
- on for 500ms, off for 500ms (slow flash)
 : Signal > 65%
- on for 250ms, off for 250ms (fast flash)
 : 40% <= Signal <= 65%
- on for 100ms, off for 100ms (very fast flash)
 : Signal < 40%

RED LED (GSM)

- on for 75ms and off for 3000ms (intermittent flash)
 : IDLE mode
- on for 600ms, off for 600ms (slow flash)
 : Limited network service
- constantly on
 : Busy with voice call
- constantly off
 : No response from GSM Module

5.10. Testing the SMS Commander

The SMS Commander (even with a blank configuration) has a built-in test feature. If the product receives “**TEST GSMC**” as an SMS message, it will reply to the number that sent the message, with the following text:

TEST MESSAGE	(Heading)
SIGNAL: 80%	(Cellular signal)
AIRTIME: 21.12	(only if Airtime checking enabled)
OUTPUT OFF	(Output status)
INPUT OFF	(Input Status)
POWER ON	(Power input status)
BATTERY: 12.3V	(Battery Voltage – Ignore if no battery connected)

6. CONFIGURATION

6.1. Administrative Commands

Command	Effect	Allowed
1. SETADM	Set the number of the sender as the administrator if no administrator is set	Anyone (if no admin is set)
2. CLRADM	Clear the current administrator	Administrator
3. WHOADM?	Replies with the administrator number	Anyone
4. SETDEFAULT	Restore to factory settings	Administrator
5. BEHAVE <X> CLEAR	Clears behaviour statement number X	Administrator
6. CLEARSTATEMENTS	Clears all behaviour statements	Administrator
7. CLEARNUMBERS	Clears all numbers in the list	Administrator
8. REPLY ON	Turn on sms command confirmation notifications	Administrator
9. REPLY OFF	Turn off sms command confirmation notifications	Administrator
10. AIRTIME *141#	Turn on airtime checking	Administrator

Please Note: Most networks provide a way to check the remaining balance on a prepaid account via supplementary data services. It normally involves dialing a specific code on the phone, to which the network will respond by displaying the remaining balance on-screen. This code needs to be given to the product so that it knows how to check the remaining balance. In the example above, the code is set at *141# - this will be different from one network to the next. The balance is contained in the status message sent in response to a **TEST** (see 5.10) message sent to the unit.

11. AIRTIME OFF	Turn off airtime checking	Administrator
------------------------	---------------------------	---------------

*Note: > If no administrator set, anyone can issue these commands

6.2. Number Management

Command	Effect	Allowed
1. ADDN 0821234567 or ADDN +27821234567	Place given number in next open slot in listed numbers	Administrator
2. REMN 0821234567 or REMN +27821234567	Remove given number from listed numbers	Administrator

*Note: > Maximum of 16 numbers can be listed (including administrator)
> If no administrator set, anyone can add or remove numbers

7. TRIGGER-ACTION BEHAVIOUR STATEMENTS

The SMS Commander is configured by defining a number of behaviour statements. Each statement takes the form of an TRIGGER-ACTION pair as follows:

BEHAVE <x> <TRIGGER> <ACTION>

You are thus able to select certain trigger conditions that will cause desired actions to be performed. Any combination of TRIGGER and ACTION conditions (see 7.1 and 7.2) can be assembled into complete statements using SMS commands (See 7.3). The SMS Commander can accept up to 8 separate behaviour statements.

7.1. Trigger Conditions

	Command	Effect	Allowed
1.	INPUT ON	As soon as input goes active (must go inactive to trigger again)	Administrator
2.	INPUT ON <x>	If input goes active and remains active for x seconds (must go inactive to trigger again)	Administrator
3.	INPUT ON <x> SEC	If input goes active and remains active for x seconds (must go inactive to trigger again)	Administrator
4.	INPUT ON <x> MIN	If input goes active and remains active for x minutes (must go inactive to trigger again)	Administrator
5.	INPUT OFF	As soon as input goes inactive (must go active to trigger again)	Administrator
6.	INPUT OFF <x>	If input goes inactive and remains inactive for x seconds (must go active to trigger again)	Administrator
7.	INPUT OFF <x> SEC	If input goes inactive and remains inactive for x seconds (must go active to trigger again)	Administrator
8.	INPUT OFF <x> MIN	If input goes inactive and remains inactive for x minutes (must go active to trigger again)	Administrator
9.	INPUT TOGGLE	As soon as input changes state	Administrator
10.	RECEIVE CALL	If voice call is received from any listed number	Administrator
11.	RECEIVE MSG	If any text message is received from any listed number	Administrator
12.	RECEIVE MSG “<text>” (max characters = 16)	If a specific text message is received from any listed number (specified message must be in quotation marks)	Administrator
13.	BATT BELOW <x>	If battery voltage goes below x	Administrator
14.	SIGNAL BELOW <x>	If signal strength goes below x percent	Administrator
15.	AIRTIME BELOW <x>	If remaining prepaid airtime credit goes below x (airtime checking must be enabled)	Administrator
16.	POWER FAIL	If mains power failure is detected (backup battery must be connected)	Administrator
17.	POWER RESTORED	If mains power is restored	Administrator

*Note: > If no administrator set, anyone can issue these commands

7.2. Action Conditions

	Command	Effect	Allowed
1.	OUTPUT ON	Activate output and leave activated	Administrator
2.	OUTPUT ON <x>	Activate output for x seconds	Administrator
3.	OUTPUT ON <x> SEC	Activate output for x seconds	Administrator
4.	OUTPUT ON <x> MIN	Activate output for x minutes	Administrator
5.	OUTPUT OFF	Deactivate output and leave deactivated	Administrator
6.	OUTPUT TOGGLE	Change current state of output	Administrator
7.	MAKE <x> CALLS TO “<number>” (max calls = 3)	Make x amount of calls to specified number (Number will automatically be added if not in list)	Administrator
8.	SEND “<text>” TO “<number>” (max characters = 16)	Send specific message to specified number (Number will automatically be added if not in list)	Administrator
9.	SEND “<text>” TO ALL (max characters = 16)	Send specific message to all listed numbers (specified message must be in quotation marks)	Administrator
10.	ANSWER	Answer an incoming voice call. (should be used with “RECEIVE CALL” trigger)	Administrator

*Note: > If no administrator set, anyone can issue these commands

7.3. Examples

➤ BEHAVE 1 INPUT ON 5 SEC SEND “ALARM TRIGGERED” TO ALL

The above SMS command will configure behaviour statement number 1 which will SMS the text message ALARM TRIGGERED to ALL listed numbers every time the input goes active and remains active for 5 seconds.

➤ BEHAVE 2 RECEIVE CALL ANSWER

The above SMS command will configure behaviour statement number 2 which will answer any incoming voice call from any listed number and only hang up when voice call is ended by caller. **Please Note:** If multiple “RECEIVE CALL ” trigger conditions are defined, and one of them answers the call (as in the above example), the statement responsible for answering the call should be defined last.

➤ BEHAVE 3 RECEIVE MSG “ARM ALARM” OUTPUT ON

The above SMS command will configure behaviour statement number 3 which will activate the output and leave it activated every time a SMS containing the text ARM ALARM is received from any listed number.

➤ BEHAVE 4 POWER FAIL SEND “POWER FAILURE” TO “0831234567”

The above SMS command will configure behaviour statement number 4 which will SMS the text message POWER FAILURE to 0831234567 every time a mains power failure is detected. (A backup battery must be connected)

➤ **BEHAVE 5 AIRTIME BELOW 20 SEND “AIRTIME LOW” TO “0823212011”**

The above SMS command will configure behaviour statement number 5 which will SMS the text message AIRTIME LOW to 0823212011 if remaining prepaid airtime goes below 20 units.

➤ **BEHAVE 6 BATT BELOW 11 SEND “BATTERY LOW” TO “0831234567”**

The above SMS command will configure behaviour statement number 6 which will SMS the text message BATTERY LOW to 0831234567 every time battery voltage goes below 11V.

8. TROUBLESHOOTING

8.1. SMS Commander does not send any SMS messages.

Cause 1: Airtime problem

The airtime on your SIM card may be depleted, or the SIM card may have been de-activated by the network. Refer to Section 5.3 (Installation: Sim Card)

Cause 2: Reception problem

You may have bad reception in your area, preventing the unit from connecting to the network. Please check using a regular cellular phone that there shows 1-2 bars of signal right next to the product. Refer to Section 5.4 (Installation: Antenna)

Cause 3: Bad configuration

You may have not configured the unit correctly. Please send a TEST (see 5.10) message to the unit, and see if it responds. If it does respond, the unit is operating correctly.

8.2. SMS Commander does not respond to Voice Calls

Cause 1: Caller ID on phone is disabled

Your Caller ID feature on your phone may be deactivated. Please refer to your phone's manual on how to enable this feature.

Cause 2: Bad configuration

You may have configured the unit incorrectly. Make sure the number you are calling from is stored in the “Numbers List” on the SMS Commander.

9. GUARANTEE

The SMS Commander is guaranteed for a period of 24 months against defects in materials or workmanship. Should your product become defective during the guarantee period it will be repaired or replaced at the sole discretion of **Polygon Technologies** under the following conditions:

A: The unit must not have been opened or otherwise tampered with. If the enclosure of any unit has been opened at all, the guarantee will be null and void.

B: The guarantee does not cover damage resulting from excessive input voltages, lightning, power surges or water ingress.

A decision about issues A and B will be at the sole discretion of **Polygon Technologies**. This guarantee does not provide for shipping costs. This will be for the account of the user under all circumstances.

10. IMPORTANT NOTICE (DISCLAIMER / COPYRIGHT)

Herein, “the Company” will mean:

Polygon Technologies CC, its directors, members, employees and agents.

Much effort has been made to ensure the contents of this manual are complete and without errors. Nonetheless, the Company cannot be held liable for any damages directly or indirectly resulting from any errors in this manual.

The Company will under no circumstances be held liable for any injuries/death or damages that result from the use of this product, irrespective of whether such injuries/death or damages resulted from a faulty product or negligence of any kind on the part of the Company.

All Information and images in this manual are proprietary to **Polygon Technologies CC**. The manual as a whole may be distributed and copied freely, but no partial content may be used/copied or distributed in any way. No part of the product (including the hardware, firmware and software) may be copied or reverse-engineered.

Polygon Technologies CC reserves the right to make changes to contents of this manual, without notice, at any time.

11. MANUFACTURER CONTACT DETAILS

Polygon Technologies may be contacted at:

Email: Info@gsmcommander.com

Web: www.gsmcommander.com

Telephone: +27(0)21 9817062

Fax: +27(0)86 6823310

Postal Address: PO Box 1125

Kuilsriver

7579

South Africa